

2026 CATALOGUE



INDOOR BUBBLES

PETS BUBBLES

SOAP BUBBLES

BUBBLE MACHINES

BUBBLE REFILL

BUBBLE TOYS

PLASTIC BUBBLES & MARBLES

FLOOR DISPLAYS



f @BubbleWorldToys





AREE ETICHETTE LABEL AREAS

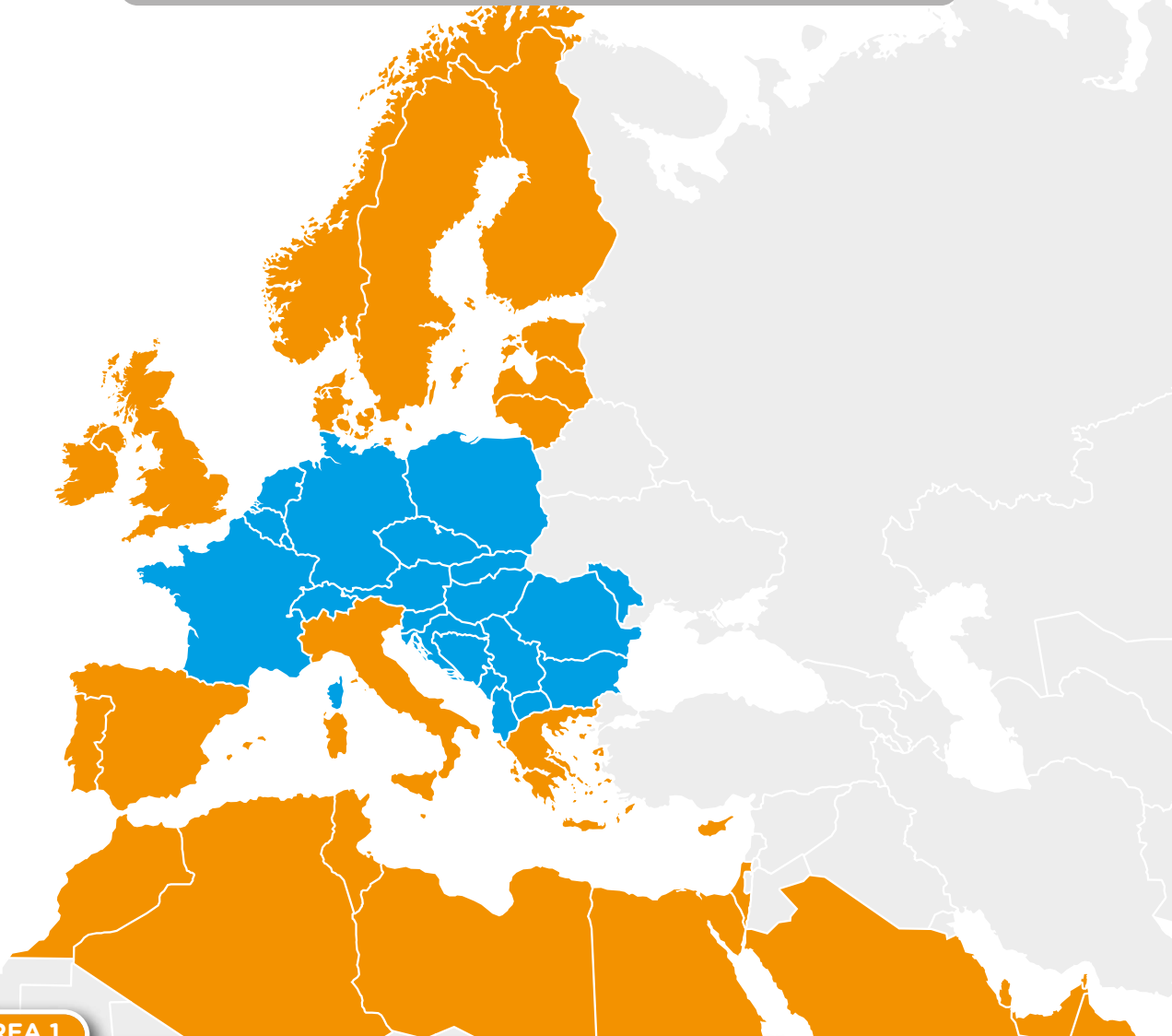

AREA 1

 DK Denmark	 GB England	 LT Lithuania	 PT Portugal
 EE Estonia	 GR Greece	 LV Latvia	 SA Saudi Arabia
 ES Spain	 IE Ireland	 MT Malta	 SE Sweden
 FI Finland	 IT Italy	 NO Norway	



AREA 2

 AT Austria	 CZ Czech Rep.	 HU Hungary	 RO Romania
 BE Belgium	 DE Germany	 LU Luxembourg	 RS Serbia
 BG Bulgaria	 FR France	 NL Netherlands	 SI Slovenia
 CH Switzerland	 HR Croatia	 PL Poland	 SK Slovakia

Sommario / Summary

TEMI E PERSONAGGI / THEMES AND CHARACTERS	4
LA NOSTRA AZIENDA / OUR COMPANY	6
QUALITÀ E CERTIFICAZIONI / QUALITY AND CERTIFICATIONS	7
BILANCIO DI SOSTENIBILITÀ / SUSTAINABILITY REPORT	8
BUBBLE WORLD INDOOR	
BUBBLE WORLD INDOOR	14
BOLLE 60 ML + SECCHIELLO MAGICO / 60 ML BUBBLES + MAGIC BUCKET	15
RICARICA / REFILL	16
MACCHINA SPARABOLLE + ESPOSITORE / BUBBLE MACHINE + FLOOR DISPLAY	17
BUBBLE WORLD PETS	
BUBBLE WORLD PETS	20
BOLLE 60 ML + PACK PETS MEDIUM / 60 ML BUBBLES + MEDIUM PACK PETS	21
RICARICA + MACCHINA SPARABOLLE + ESPOSITORE / BUBBLE MACHINE + REFILL + FLOOR DISPLAY	22
BOLLE DI SAPONE / SOAP BUBBLES	
FORMATI / SIZES	24
STANDARD 60 ML DISPLAY	25
MAXI 175 ML DISPLAY	35
GLASS 300 ML DISPLAY	40
3-PACK	45
BLISTERCARD su richiesta / on demand	46
PACKS su richiesta / on demand	47
BOLLE PERSONALIZZABILI / CUSTOMIZABLE BUBBLES	49
MACCHINE BOLLE / BUBBLE MACHINES	
MACCHINE BOLLE / BUBBLE MACHINES	52
RICARICA BOLLE / BUBBLE REFILL	
RICARICA BOLLE / BUBBLE REFILL	54
GIOCABOLLE / BUBBLE TOYS	
SPADA BOLLE / BUBBLE WAND	62
PISTOLE BOLLE / BUBBLE GUN	67
KIT BOLLE GIGANTI / GIANT BUBBLE KIT	75
FLYING DISC E BOLLE / FLYING DISC & BUBBLES	76
BOLLE DI PLASTICA E PALLINE / PLASTIC BUBBLES & MARBLES	
BOLLE DI PLASTICA / PLASTIC BUBBLES	80
PALLINE DI PLASTICA / PLASTIC MARBLES (Cheecoting)	82
BIGLIE DI VETRO / GLASS MARBLES	83
PALL-BOX / FLOOR DISPLAYS	
PALL-BOX / FLOOR DISPLAYS	86

LEGENDA SIMBOLI / SYMBOLS

 IN ESAURIMENTO STOCK DEPLETION	 GRAFICA IN AGGIORNAMENTO UNDER RESTYLING	 GRAFICA AGGIORNATA IN ARRIVO RESTYLING COMING SOON
---	---	---

Dulcop si riserva la facoltà di apportare modifiche tecniche ed estetiche ai prodotti di questo catalogo, senza alcun preavviso.
Dulcop reserves the right to make technical and aesthetic changes on the products of this catalogue, without prior notice.

Temi e personaggi - Themes and characters



GENERIC	ITALIAN BUBBLE ROT	CLASSIC	COLOR	PARTY	SPACE	ANIMAL	
	SEA	UNICORN	FOUR SEASONS				
DISNEY	STITCH & ANGEL	TOY STORY 5	WINNIE 100	STITCH	MICKEY	MINNIE	
	PRINCESS	FROZEN	CARS	DISNEY	DISNEY CLASSIC	PIXAR	
	DISNEY/MARVEL MIX	AVENGERS / PRINCESS					
MARVEL	AVENGERS	SPIDER-MAN	SPIDEY & HIS FRIENDS	SANRIO	HELLO KITTY	HELLO KITTY & FRIENDS	
SEGA	MODERN SONIC	MATTTEL	MASTERS OF THE UNIVERSE	BARBIE	HOT WHEELS	HOT WHEELS / BARBIE	
HASBRO	PLAY-DOH	PEPPA PIG	PJ MASKS	BBC	BLUEY	ACAMAR	BING
UNIVERSAL	JURASSIC WORLD	GABBY'S DOLLHOUSE	MINIONS	DREAMWORKS	PARAMOUNT	PAW PATROL	



DISPONIBILE SU RICHIESTA (QUANTITÀ MINIMA NECESSARIA)
AVAILABLE UPON REQUEST (MINIMUM ORDER QUANTITY REQUIRED)



La nostra azienda

Our Company



Chi siamo

Siamo presenti in oltre 50 Paesi offrendo oltre 300 articoli Bubble World, comprese licenze e novità stagionali.

Una logistica avanzata e doppi controlli qualità assicurano sicurezza e rapidità. Con produzione interna a Bologna, Dulcop è l'unico produttore italiano e leader europeo.

Affidabilità, esperienza e cura quotidiana ci rendono un partner sicuro, flessibile e orientato al valore del Made in Italy.

Who we are

We operate in over 50 countries offering 300+ Bubble World products, including licensed lines and seasonal innovations.

Advanced logistics and dual quality controls ensure safety and speed. With fully in-house production in Bologna, Dulcop is Italy's only bubble producer and a European leader.

Reliability, expertise and daily care make us a trusted, flexible partner committed to true Made in Italy quality.



I nostri valori

La nostra eccellenza industriale italiana guida un percorso di miglioramento continuo, sostenuto da un dipartimento interno di Ricerca e Sviluppo.

Mettiamo al centro sicurezza, persone e ambiente, con un impegno quotidiano che trasforma responsabilità e qualità in un valore concreto per partner e consumatori.

Our values

Our Italian industrial excellence drives continuous improvement, supported by an in-house Research & Development team.

We prioritize safety, people and the environment, turning daily responsibility into measurable quality. This commitment ensures reliable, responsible value for every partner and consumer who chooses Dulcop.



La nostra forza

Dal granulato al prodotto finito, tutto il processo produttivo delle nostre bolle di sapone è realizzato in-house: questo ci permette di garantire qualità, flessibilità e rapidità nella gestione del cliente, sia per le grafiche a licenza che per le personalizzazioni.

Massima capacità produttiva giornaliera:
600.000 flaconi 60 ml
120.000 lt di liquido

Our core asset

Our production process is entirely carried out in our facilities, covering the entire supply chain from raw materials to the finished product. This allows for continuous quality control, as well as greater flexibility and speed in meeting customization requests.

*Daily maximum production capacity:
600.000 pcs. of 60 ml bottles
120.000 lt solution*



Qualità e Certificazioni - Quality and Certifications

La qualità, per noi, è una promessa mantenuta ogni giorno. Dalla sicurezza delle persone che lavorano con noi alla tracciabilità dei processi produttivi, ogni fase è guidata da attenzione e controllo. Lo dimostrano le certificazioni che rinnoviamo ogni anno: riconoscimenti ufficiali, nazionali e internazionali, che attestano un impegno reale, costante e trasparente.

For us, quality is a promise kept every day. From the safety of the people who work with us to the traceability of our production processes, every step is guided by care and control. The national and international certifications we renew every year are proof of our real, constant, and transparent commitment to it.

QUALITÀ - QUALITY



Approccio ESG integrato.
Integrated ESG approached.



Carta e cartone realizzati con materie prime derivanti da foreste correttamente gestite (FSC).
Paper and card board packaging made of materials derived from sustainable forests (FSC).



Eccellenza italiana, stile e impegno per prodotti di alta qualità.
Italian excellence, style and commitment for high quality products.



Meno plastica nei nostri flaconi.
Less plastics in our bottles.



Produzione in economia circolare per un uso efficiente delle risorse e ridurre l'impatto ambientale.
Circular economy production for efficient use of resources and reduce environmental impact.



Formula effetto asciutto - non lascia residui.
Dry effect formula - no residues.



Soluzione priva di glutine.
Gluten-free solution.



Non testato su animali.
Not tested on animals.



Senza parabeni.
Paraben free.



Riempibile e riutilizzabile.
Refillable and reusable.

CERTIFICAZIONI - CERTIFICATIONS



Sistema di gestione della qualità certificato.
Certified quality management system.



Codice di comportamento amfori BSCI per i diritti etici del lavoro e tutela dell'ambiente.
Code of conduct for the ethical rights of workers and the protection of the environment.



Classification, Labeling & Packaging Regolamento per la sicurezza del liquido.
Regulation for the safety of the bubble solution.



Certificazione per le normative del giocattolo nei paesi del Golfo.
Certification for the toy technical regulations of the Gulf Countries.



Certificazione (su richiesta) per la sicurezza del liquido sulla pelle.
Certification (upon request) for the safety of the bubble solution on the skin.



Certificazione per la sicurezza del giocattolo.
Certification for the toy safety.

BILANCIO DI SOSTENIBILITÀ 2024 DULCOP INTERNATIONAL S.P.A.

Il Bilancio di Sostenibilità di Dulcop International S.p.A. nasce dal contributo di tutte le funzioni aziendali, unite dall'impegno di raccontare in modo trasparente, concreto e misurabile il nostro percorso verso un futuro più responsabile.

Per Dulcop, la sostenibilità è una forma di bellezza consapevole: leggera come una bolla di sapone, ma fondata su valori solidi – sicurezza, fiducia, qualità e responsabilità. Ogni bolla che produciamo riflette questo impegno: trasformare l'innovazione in etica, la cura in valore, la leggerezza in un gesto di rispetto verso le persone e il pianeta.

Edizione ottobre 2025

2024 SUSTAINABILITY REPORT DULCOP INTERNATIONAL S.P.A.

The Sustainability Report of Dulcop International S.p.A. is the result of contributions from every company department, all united in their commitment to a transparent, concrete, and measurable journey toward a more responsible future.

For Dulcop, sustainability is a form of conscious beauty: as light as a soap bubble, yet grounded in solid values – safety, trust, quality, and responsibility. Every bubble we produce reflects this commitment: transforming innovation into ethics, care into value, and lightness into a gesture of respect for both people and the planet.

October 2025 edition

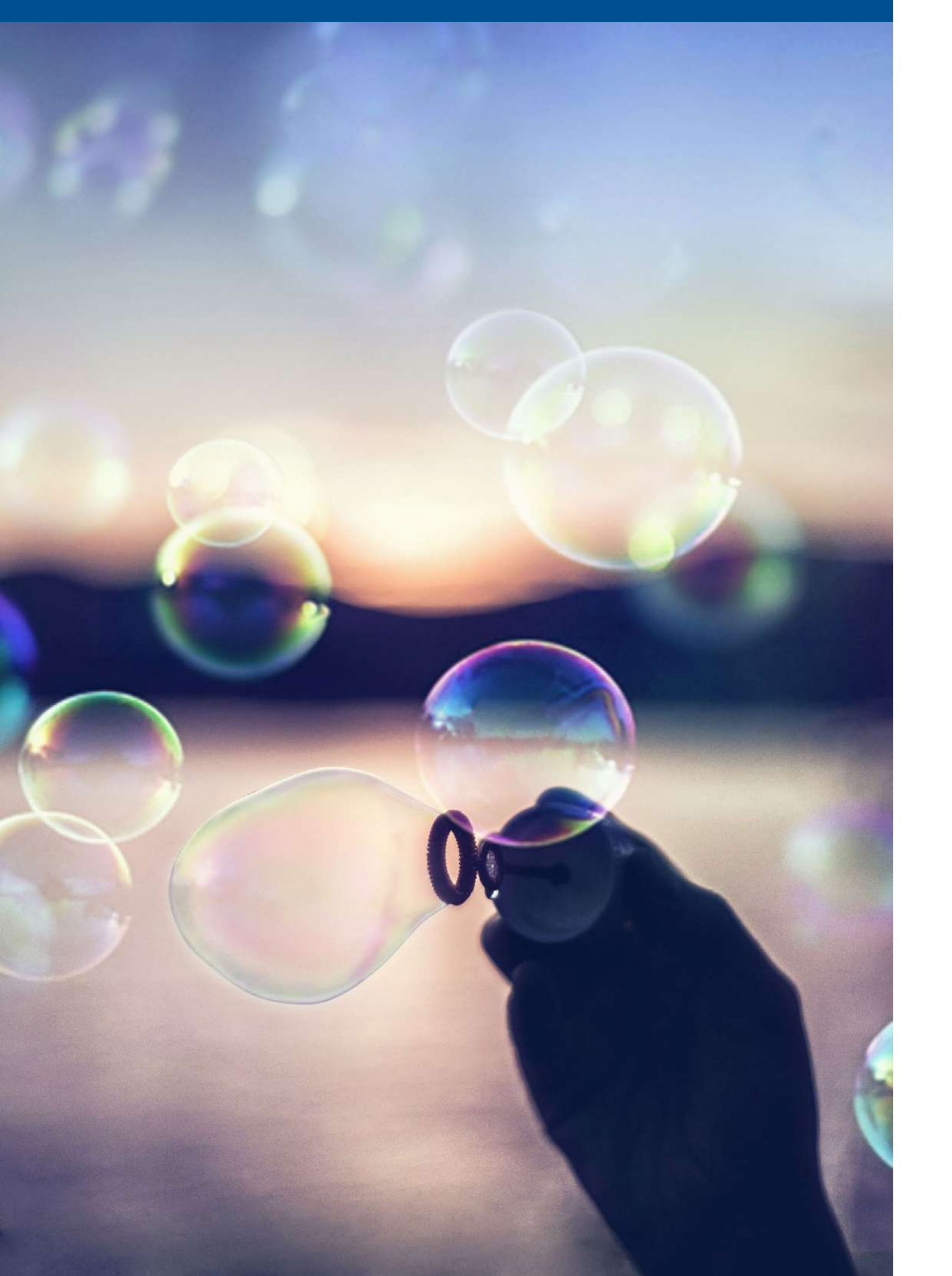

FRANCOBOLLO DULCOP

LA FABBRICA
DELLE BOLLE

DULCOP

DAL 1938
A BOLOGNA

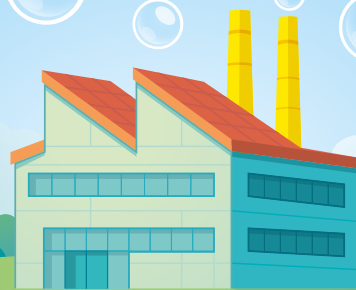

ITALIA



I.P.Z.S. S.p.A. - ROMA - 2025

Dulcop riconosciuta tra le Eccellenze del Made in Italy!

Siamo orgogliosi di essere stati celebrati con un francobollo dedicato nella serie "Le Eccellenze del Sistema Produttivo e del Made in Italy", promossa dal Ministero del Made in Italy e da Poste Italiane.

Dietro la magia delle bolle di sapone c'è un mondo di ricerca, know-how e responsabilità che da decenni, ogni giorno portiamo avanti con coerenza e determinazione.

Un riconoscimento che racconta la nostra storia e guarda al futuro!

Dulcop among the Excellences of Made in Italy!

We're honored to be celebrated with a dedicated stamp in the philatelic series "Excellences of the Italian Industry and Made in Italy", promoted by the Italian Ministry of Made in Italy and Poste Italiane. Behind the simple magic of a soap bubble lie decades of research, industrial know-how, and dedication to quality – values that have guided us since the very beginning.

A recognition that celebrates our story and looks to the future!



Dulcop International S.p.A.

via Lombardia 48, 40024

Castel San Pietro Terme, Bologna (BO)

Italia

NEW **bubble** world TOYS





@BubbleWorldToys



by



Bubble world inD^{or}



NEW

THE ORIGINAL



Per la prima volta, giocare con le bolle di sapone è possibile anche dentro casa. Una formula rivoluzionaria che cambia le regole del gioco.

Non bagna. Non lascia residui. Sicura e testata come sempre.

Benefits per retailers e distributori

- Estensione stagionale: vendite tutto l'anno
- Nuove opportunità di posizionamento in store (non solo outdoor)
- Maggiore valore percepito grazie all'innovazione di prodotto
- Maggiore rotazione a scaffale e ampliamento del target d'acquisto
- Su richiesta, integrabile con linee tematiche e licenze

*For the first time ever, playing with bubbles is possible even indoors.
A revolutionary formula that changes the rules of the game.*

It doesn't wet surfaces. It leaves no residue. Safe and tested, as always.

Benefits for retailers and distributors

- *Extended seasonality: year-round sales opportunities*
- *New in-store placement options - beyond the outdoor section*
- *Higher perceived value thanks to product innovation*
- *Increased shelf rotation and a broader consumer base*
- *Customizable on request with themed collections and licensed lines*



INDOOR - Standard 60ml bubbles



AREA 1

DK EE ES FI GB
GR IE IT LT LV MT
NO PT SA SE

103044010001

AREA 2

AT BE BG CH CZ
DE FR HR HU LU NL
PL RO RS SI SK

103044310001

display

36 pz / pcs
cm 23,5 x 23,5 x 12

cartone / carton

6 displays
216 pz / pcs
cm 25 x 48,7 x 37
kg 17,4

DAT TECNICI - TECHNICAL DATA

epal pallet cm 80 x 120

30 ct / cts

INDOOR - Magic Bubble Bucket



NO
SPILL



500041010001



scatola

cm 16,5 x 12,3 x 15,1

cartone / carton

12 scatole
cm 47 x 35 x 27
kg 5

DAT TECNICI - TECHNICAL DATA

epal pallet cm 80 x 120

28 ct / cts

INDOOR Bubble Refill 0.5



103045010000

REFILL 0.5



DAT TECNICI - TECHNICAL DATA

flacone / bottle
0,5 L - 17,5 fl oz UK

cartone / carton
25 pz/pcs
cm 35,3 x 35,3 x 23,2
kg 14

epal pallet cm 80 x 120
42 ct / cts

INDOOR Bubble Refill 1



103046010000

REFILL 1



DAT TECNICI - TECHNICAL DATA

flacone / bottle
1 L - 35,1 fl oz UK

cartone / carton
12 pz/pcs
cm 26 x 34,5 x 28
kg 13,1

epal pallet cm 80 x 120
45 ct / cts

**READY
TO USE**

INDOOR Bubble Refill 3



on request

DAT TECNICI - TECHNICAL DATA

flacone / bottle
3 L - 0,66 gal UK

cartone / carton
4 pz/pcs
cm 40 x 30 x 19
kg 13,3

epal pallet cm 80 x 120
40 ct / cts

INDOOR Bubble Refill 5



on request

DAT TECNICI - TECHNICAL DATA

flacone / bottle
5 L - 1,09 gal UK
kg 5,40

epal pallet cm 80 x 120
90 pz / pcs

INDOOR - USB Bubble Machine

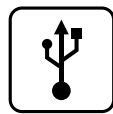

Cavetto USB incluso.
USB cable included.

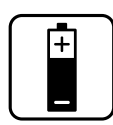

Necessita 4 batterie AA.
4 AA Batteries needed.



500042010000

USB BUBBLE MACHINE



DAT TECNICI - TECHNICAL DATA	scatola / box
	cm 23 x 12,5 x 14 Kg 0,45
	epal pallet cm 80 x 120
	12 pz / pcs per ct 24 cts per pallet

INDOOR - Pall-box

clip strip laterali
disponibili su
richiesta

side clip strips
available upon
request



disponibili anche
versione in
italiano

*italian version
also available*

133036110001

DAT TECNICI - TECHNICAL DATA	pall-box
	cm 30 x 37 x 137 max kg 26
	epal pallet cm 80 x 120
	8 pall-box



@BubbleWorldToys



by





NEW!

also for
INDOOR
use

the
ORIGINAL
SCENTED
BUBBLES



PETS BUBBLES

Dulcop porta la sua esperienza di oltre 60 anni anche nel mondo degli amici a quattro zampe, con una linea innovativa pensata per il gioco condiviso tra persone e animali. Nasce così Bubble World Pets, le bolle di sapone create per stimolare la curiosità, l'interazione e la gioia dei nostri compagni pelosi.

Con profumazioni uniche e sicure - per i cani e per i gatti - trasformiamo ogni momento in un'esperienza multisensoriale, leggera e coinvolgente.

Come ogni prodotto Dulcop, anche Bubble World Pets si fonda su una filiera certificata e controllata, con la massima attenzione alla sicurezza, alla sostenibilità e alla qualità. È il nostro modo di coniugare gioco, innovazione e responsabilità, aprendo nuovi mondi di felicità condivisa. Perché la nostra visione non cambia: creare emozioni attraverso le bolle, oggi anche con chi ci accompagna ogni giorno con uno sguardo, una carezza e una coda che scodinzola.

Dulcop brings over 60 years of expertise to the world of our four-legged friends with an innovative line designed to share happy moments with them. This is the idea behind Bubble World Pets - soap bubbles created to spark curiosity, interaction, and joy for our furry companions.

With unique and safe scents - for dogs and for cats - every moment becomes a light, engaging, and multisensory experience.

Like all Dulcop products, Bubble World Pets lies on a certified and controlled supply chain, complying with the highest standards of safety, sustainability, and quality. It's our way of combining play, innovation, and responsibility, opening new worlds of shared happiness. Our vision remains the same: creating emotions through bubbles, now also with those who greet us every day with a look, a touch, and a wagging tail.

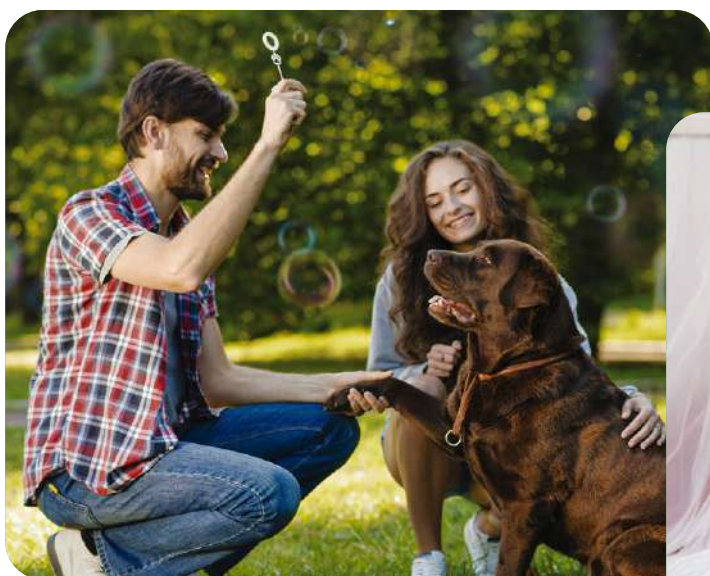

PETS DOG - Display 12pcs

AREA 1

DK EE ES FI GB
GR IE IT LT LV MT
NO PT SA SE

103047010001

AREA 2

AT BE BG CH CZ
DE FR HR HU LU NL
PL RO RS SI SK

103047310001



DAT TECNICI - TECHNICAL DATA

display

12 pz / pcs
cm 16,9 x 12,5 x 11,5

cartone / carton

8 displays
96 pz / pcs
cm 26,5 x 33,5 x 26,25
kg 9

epal pallet cm 80 x 120

45 ct / cts

PETS BUBBLES

PRODUCT



DISPLAY



PETS CAT - Display 12pcs

AREA 1

DK EE ES FI GB
GR IE IT LT LV MT
NO PT SA SE

103048010001

AREA 2

AT BE BG CH CZ
DE FR HR HU LU NL
PL RO RS SI SK

103048310001



DAT TECNICI - TECHNICAL DATA

display

12 pz / pcs
cm 16,9 x 12,5 x 11,5

cartone / carton

8 displays
96 pz / pcs
cm 26,5 x 33,5 x 26,25
kg 9

epal pallet cm 80 x 120

45 ct / cts

PRODUCT



DISPLAY



PETS DOG - Pack 2pcs + 1 bouncing ball

103051010001

PRODUCT



DAT TECNICI - TECHNICAL DATA

box

2 pz + 1 palla /
2 pcs + 1 ball Ø cm 7

cartone / carton

26 boxes
cm 28,50 x 80,50 x 20,50
kg 6,6

epal pallet cm 80 x 120

42 ct / cts

PETS DOG Bubble Refill 0.5



103049010001



DAT TECNICI - TECHNICAL DATA

flacone / bottle
0,5 L - 17,5 fl oz UK
cartone / carton
24 pz/pcs
cm 21 x 55 x 23
kg 14
epal pallet cm 80 x 120
49 ct / cts

PETS CAT Bubble Refill 0.5



103050010001



DAT TECNICI - TECHNICAL DATA

flacone / bottle
0,5 L - 17,5 fl oz UK
cartone / carton
24 pz/pcs
cm 21 x 55 x 23
kg 14
epal pallet cm 80 x 120
49 ct / cts

PETS - Pall-box

clip strip laterali
disponibili su
richiesta

side clip strips
available upon
request



disponibili anche
versione in
italiano

italian version
also available



133037110001

DAT TECNICI - TECHNICAL DATA

pall-box
cm 30 x 37 x 137
max kg 26
epal pallet cm 80 x 120
8 pall-box

Bolle di sapone

Soap bubbles



FORMATI - SIZES

STANDARD

60 ml
2,1 fl oz UK

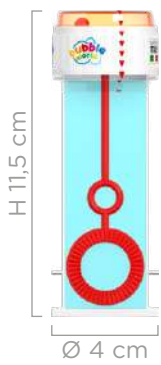

MAXI

175 ml
6,1 fl oz UK

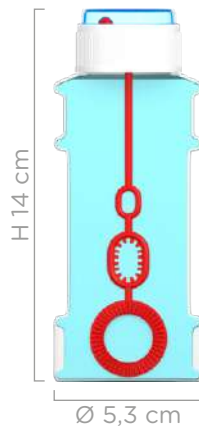

GLASS

300 ml
10,5 fl oz UK

Flacone trasparente
Transparent bottle

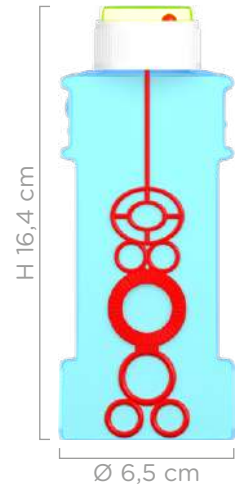

REFILL 0.5

0,5 L
17,5 fl oz UK

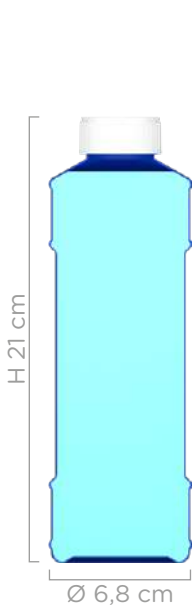

REFILL 1.0

1 L
35,1 fl oz UK

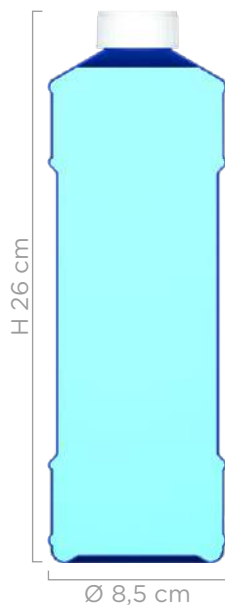

REFILL 3.0

3 L
0,66 gal UK



REFILL 5.0

5 L
1,09 gal UK

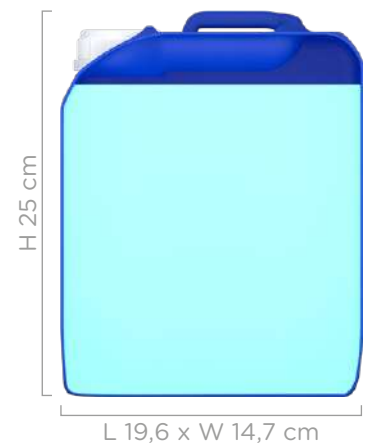

**Safety
commitment**



Sigillo di sicurezza
sul tappo.

*Sleeved seal
on the top.*

Gluten Free.
Hypoallergenic.
Paraben Free.

Lotto di produzione
impresso sulla flacone.

*Batch of production
printed on the bottle.*

Liquido 100%
microbiologicamente
testato.

*100% microbiologically
tested solution.*

La forma dei flaconi
è un marchio 3D
registrato.

*The bottle shape
is registered as 3D
trade mark.*



**Environmental
commitment**



Riempibile e
riutilizzabile.
*Refillable and
reusable.*



Flacone, tappo,
soffiatore, vetrino
e pallina in mono
materiale.

*Mono-material bottle,
cap, blower, lid and
ball.*

Componenti prodotto
interamente riciclabili.

*Product components
fully recyclable.*

SOAP BUBBLES

**Playability
commitment**

Soffiatore inserito
nel tappo.

Built-in wand.

Gioco sul tappo.
Game on the top.

Testato per resistere alle
diverse condizioni
climatiche.
*Tested to withstand
different climatic conditions.*

Pallina di plastica
(non si ossida).

*Plastic ball
(does not oxidize).*



DAT TECNICI - TECHNICAL DATA

display

36 pz / pcs
cm 23,5 x 23,5 x 12

cartone / carton

6 displays
216 pz / pcs
cm 25 x 48,7 x 37
kg 17,4

epal pallet cm 80 x 120

30 ct / cts

NEW!

Italian Bubble Rot Bubbles

PRODUCT



AREA 1

DK EE ES FI GB
GR IE IT LT LV MT
NO PT SA SE

103001010054

AREA 2

AT BE BG CH CZ
DE FR HR HU LU NL
PL RO RS SI SK

103001310054

Classic Bubbles

PRODUCT



AREA 1

DK EE ES FI GB
GR IE IT LT LV MT
NO PT SA SE

103001010001

AREA 2

AT BE BG CH CZ
DE FR HR HU LU NL
PL RO RS SI SK

103001310001

Color Bubbles

PRODUCT



AREA 1

DK EE ES FI GB
GR IE IT LT LV MT
NO PT SA SE

103001010002

AREA 2

AT BE BG CH CZ
DE FR HR HU LU NL
PL RO RS SI SK

103001310002

Party Bubbles

PRODUCT



AREA 1

DK EE ES FI GB
GR IE IT LT LV MT
NO PT SA SE

103001010006

AREA 2

AT BE BG CH CZ
DE FR HR HU LU NL
PL RO RS SI SK

103001310006

Space Bubbles

PRODUCT



AREA 1

DK EE ES FI GB
GR IE IT LT LV MT
NO PT SA SE

103001010048

AREA 2

AT BE BG CH CZ
DE FR HR HU LU NL
PL RO RS SI SK

103001310048

Animal Bubbles

PRODUCT



8 007315 828000

DISPLAY



8 007315 082808



AREA 1

DK EE ES FI GB
GR IE IT LT LV MT
NO PT SA SE

103001010005

AREA 2

AT BE BG CH CZ
DE FR HR HU LU NL
PL RO RS SI SK

103001310005

Sea Bubbles

PRODUCT



8 007315 434003

DISPLAY



8 007315 043403



AREA 1

DK EE ES FI GB
GR IE IT LT LV MT
NO PT SA SE

103001010003

AREA 2

AT BE BG CH CZ
DE FR HR HU LU NL
PL RO RS SI SK

103001310003

Unicorn Bubbles

PRODUCT



8 007315 804509

DISPLAY



8 007315 080453



AREA 1

DK EE ES FI GB
GR IE IT LT LV MT
NO PT SA SE

103001010004

AREA 2

AT BE BG CH CZ
DE FR HR HU LU NL
PL RO RS SI SK

103001310004

Four Seasons Bubbles

PRODUCT



8 007315 843003

DISPLAY



8 007315 084307



AREA 1

DK EE ES FI GB
GR IE IT LT LV MT
NO PT SA SE

103001010007

AREA 2

AT BE BG CH CZ
DE FR HR HU LU NL
PL RO RS SI SK

103001310007

NEW!

Stitch & Angel Bubbles

PRODUCT



8 007315 010474

DISPLAY



8 007315 010481



AREA 1

DK EE ES FI GB
GR IE IT LT LV MT
NO PT SA SE

103001010058

AREA 2

AT BE BG CH CZ
DE FR HR HU LU NL
PL RO RS SI SK

103001310058

NEW!

Toy Story 5 Bubbles

PRODUCT



8 007315 010436

DISPLAY



8 007315 010443

disponibile da
fine Aprile 2026

available from
end of April 2026



AREA 1

DK EE ES FI GB
GR IE IT LT LV MT
NO PT SA SE

103001010057

AREA 2

AT BE BG CH CZ
DE FR HR HU LU NL
PL RO RS SI SK

103001310057

NEW!

Winnie 100 Bubbles

PRODUCT



8 007315 442206

DISPLAY



8 007315 044226



AREA 1

DK EE ES FI GB
GR IE IT LT LV MT
NO PT SA SE

103001010015

AREA 2

AT BE BG CH CZ
DE FR HR HU LU NL
PL RO RS SI SK

103001310015

Stitch Bubbles

PRODUCT



8 007315 007931

DISPLAY



8 007315 007948



AREA 1

DK EE ES FI GB
GR IE IT LT LV MT
NO PT SA SE

103001010043

AREA 2

AT BE BG CH CZ
DE FR HR HU LU NL
PL RO RS SI SK

103001310043

Mickey Bubbles

PRODUCT



8 007315 410021

DISPLAY



8 007315 041201



AREA 1

DK EE ES FI GB
GR IE IT LT LV MT
NO PT SA SE

103001010010

AREA 2

AT BE BG CH CZ
DE FR HR HU LU NL
PL RO RS SI SK

103001310010

Minnie Bubbles

PRODUCT



8 007315 538008

DISPLAY



8 007315 053808



AREA 1

DK EE ES FI GB
GR IE IT LT LV MT
NO PT SA SE

103001010011

AREA 2

AT BE BG CH CZ
DE FR HR HU LU NL
PL RO RS SI SK

103001310011

BOLLE DI SAPONE

**Princess
Bubbles**

PRODUCT



8 007315 448000

DISPLAY



8 007315 044806



AREA 1

DK EE ES FI GB
GR IE IT LT LV MT
NO PT SA SE

103001010012

AREA 2

AT BE BG CH CZ
DE FR HR HU LU NL
PL RO RS SI SK

103001310012

**Frozen
Bubbles**

PRODUCT



8 007315 823005

DISPLAY



8 007315 082303



AREA 1

DK EE ES FI GB
GR IE IT LT LV MT
NO PT SA SE

103001010013

AREA 2

AT BE BG CH CZ
DE FR HR HU LU NL
PL RO RS SI SK

103001310013

**Cars
Bubbles**

PRODUCT



8 007315 490009

DISPLAY



8 007315 049009



AREA 1

DK EE ES FI GB
GR IE IT LT LV MT
NO PT SA SE

103001010014

AREA 2

AT BE BG CH CZ
DE FR HR HU LU NL
PL RO RS SI SK

103001310014

**Disney Multi P.
Bubbles**

PRODUCT



8 007315 820004

DISPLAY



8 007315 282000



AREA 1

DK EE ES FI GB
GR IE IT LT LV MT
NO PT SA SE

103001010018

AREA 2

AT BE BG CH CZ
DE FR HR HU LU NL
PL RO RS SI SK

103001310018

**Disney Classic
Bubbles**

PRODUCT



8 007315 842501

DISPLAY



8 007315 084253



AREA 1

DK EE ES FI GB
GR IE IT LT LV MT
NO PT SA SE

103001010019

AREA 2

AT BE BG CH CZ
DE FR HR HU LU NL
PL RO RS SI SK

103001310019

SOAP BUBBLES

Pixar Multi P. Bubbles

PRODUCT
8 007315 840002

DISPLAY
8 007315 084000



AREA 1

DK EE ES FI GB
GR IE IT LT LV MT
NO PT SA SE

103001010020

AREA 2

AT BE BG CH CZ
DE FR HR HU LU NL
PL RO RS SI SK

103001310020

Disney/Marvel Mix Bubbles

PRODUCT
8 007315 008792

DISPLAY
8 007315 008785



AREA 1

DK EE ES FI GB
GR IE IT LT LV MT
NO PT SA SE

103001010049

AREA 2

AT BE BG CH CZ
DE FR HR HU LU NL
PL RO RS SI SK

103001310049

Avengers/Princess Bubbles

PRODUCT
8 007315 885102

DISPLAY
8 007315 088510



AREA 1

DK EE ES FI GB
GR IE IT LT LV MT
NO PT SA SE

103001010037

AREA 2

AT BE BG CH CZ
DE FR HR HU LU NL
PL RO RS SI SK

103001310037

Avengers Bubbles

PRODUCT
8 007315 559003

DISPLAY
8 007315 055901



AREA 1

DK EE ES FI GB
GR IE IT LT LV MT
NO PT SA SE

103001010017

AREA 2

AT BE BG CH CZ
DE FR HR HU LU NL
PL RO RS SI SK

103001310017

Spider-Man Bubbles

PRODUCT
8 007315 513005

DISPLAY
8 007315 051309



AREA 1

DK EE ES FI GB
GR IE IT LT LV MT
NO PT SA SE

103001010009

AREA 2

AT BE BG CH CZ
DE FR HR HU LU NL
PL RO RS SI SK

103001310009

Spidey & Friends Bubbles

PRODUCT



8 007315 008327

DISPLAY



8 007315 008334



AREA 1

DK EE ES FI GB
GR IE IT LT LV MT
NO PT SA SE

103001010046

AREA 2

AT BE BG CH CZ
DE FR HR HU LU NL
PL RO RS SI SK

103001310046

Hello Kitty Bubbles

PRODUCT



8 007315 008884

DISPLAY



8 007315 008891



AREA 1

DK EE ES FI GB
GR IE IT LT LV MT
NO PT SA SE

103001010051

AREA 2

AT BE BG CH CZ
DE FR HR HU LU NL
PL RO RS SI SK

103001310051

SOAP BUBBLES

Hello Kitty & Friends Bubbles

PRODUCT



8 007315 009096

DISPLAY



8 007315 009102



AREA 1

DK EE ES FI GB
GR IE IT LT LV MT
NO PT SA SE

103001010052

AREA 2

AT BE BG CH CZ
DE FR HR HU LU NL
PL RO RS SI SK

103001310052

NEW!

Modern Sonic Bubbles

PRODUCT



8 007315 009874

DISPLAY



8 007315 009881



AREA 1

DK EE ES FI GB
GR IE IT LT LV MT
NO PT SA SE

103001010056

AREA 2

AT BE BG CH CZ
DE FR HR HU LU NL
PL RO RS SI SK

103001310056

NEW!

Masters of the Universe Bubbles

PRODUCT



8 007315 010511

DISPLAY



8 007315 010498



AREA 1

DK EE ES FI GB
GR IE IT LT LV MT
NO PT SA SE

103001010059

AREA 2

AT BE BG CH CZ
DE FR HR HU LU NL
PL RO RS SI SK

103001310059

Barbie Bubbles



AREA 1

DK EE ES FI GB
GR IE IT LT LV MT
NO PT SA SE

103001010021

AREA 2

AT BE BG CH CZ
DE FR HR HU LU NL
PL RO RS SI SK

103001310021

Hot Wheels Bubbles



AREA 1

DK EE ES FI GB
GR IE IT LT LV MT
NO PT SA SE

103001010022

AREA 2

AT BE BG CH CZ
DE FR HR HU LU NL
PL RO RS SI SK

103001310022

Hot Wheels / Barbie Bubbles



AREA 1

DK EE ES FI GB
GR IE IT LT LV MT
NO PT SA SE

103001010038

AREA 2

AT BE BG CH CZ
DE FR HR HU LU NL
PL RO RS SI SK

103001310038

Play-Doh Bubbles



AREA 1

DK EE ES FI GB
GR IE IT LT LV MT
NO PT SA SE

103001010034

AREA 2

AT BE BG CH CZ
DE FR HR HU LU NL
PL RO RS SI SK

103001310034

Peppa Pig Bubbles



AREA 1

DK EE ES FI GB
GR IE IT LT LV MT
NO PT SA SE

103001010023

AREA 2

AT BE BG CH CZ
DE FR HR HU LU NL
PL RO RS SI SK

103001310023

**PJ Masks
Bubbles**

PRODUCT



8 007315 697002

DISPLAY



8 007315 069700



AREA 1

DK EE ES FI GB
GR IE IT LT LV MT
NO PT SA SE

103001010027

AREA 2

AT BE BG CH CZ
DE FR HR HU LU NL
PL RO RS SI SK

103001310027

**Bluey
Bubbles**

PRODUCT



8 007315 845007

DISPLAY



8 007315 384506



AREA 1

DK EE ES FI GB
GR IE IT LT LV MT
NO PT SA SE

103001010036

AREA 2

AT BE BG CH CZ
DE FR HR HU LU NL
PL RO RS SI SK

103001310036

**Bing
Bubbles**

PRODUCT



8 007315 819008

DISPLAY



8 007315 081900



AREA 1

DK EE ES FI GB
GR IE IT LT LV MT
NO PT SA SE

103001010031

AREA 2

AT BE BG CH CZ
DE FR HR HU LU NL
PL RO RS SI SK

103001310031

**Jurassic World
Bubbles**

PRODUCT



8 007315 848008

DISPLAY



8 007315 084802



AREA 1

DK EE ES FI GB
GR IE IT LT LV MT
NO PT SA SE

103001010033

AREA 2

AT BE BG CH CZ
DE FR HR HU LU NL
PL RO RS SI SK

103001310033

**Gabby's Dollhouse
Bubbles**

PRODUCT



8 007315 008013

DISPLAY



8 007315 008020



AREA 1

DK EE ES FI GB
GR IE IT LT LV MT
NO PT SA SE

103001010045

AREA 2

AT BE BG CH CZ
DE FR HR HU LU NL
PL RO RS SI SK

103001310045

SOAP BUBBLES

Minions Bubbles



AREA 1

DK EE ES FI GB
GR IE IT LT LV MT
NO PT SA SE

103001010028

AREA 2

AT BE BG CH CZ
DE FR HR HU LU NL
PL RO RS SI SK

103001310028

Dreamworks Multi P. Bubbles



AREA 1

DK EE ES FI GB
GR IE IT LT LV MT
NO PT SA SE

103001010030

AREA 2

AT BE BG CH CZ
DE FR HR HU LU NL
PL RO RS SI SK

103001310030

PAW Patrol Bubbles



AREA 1

DK EE ES FI GB
GR IE IT LT LV MT
NO PT SA SE

103001010025

AREA 2

AT BE BG CH CZ
DE FR HR HU LU NL
PL RO RS SI SK

103001310025

Bolle di sapone Soap bubbles



MAXI - display
175 ml - 6,1 fl oz UK

Safety commitment



Gluten Free.
Hypoallergenic.
Paraben Free.

Lotto di produzione
impresso sulla flacone.
*Batch of production
printed on the bottle.*

Liquido 100%
microbiologicamente
testato.
*100% microbiologically
tested solution.*



Environmental commitment



Riempibile e
riutilizzabile.
*Refillable and
reusable.*



Componenti prodotto
interamente riciclabili.
*Product components
fully recyclable.*

SOAP BUBBLES

Playability commitment

Soffiatore inserito
nel tappo.
Built-in wand.

Gioco sul tappo.
Game on the top.

Testato per resistere alle
diverse condizioni
climatiche.
*Tested to withstand
different climatic conditions.*

Pallina di plastica
(non si ossida).
*Plastic ball
(does not oxidize).*



DAT TECNICI - TECHNICAL DATA

display

16 pz / pcs
cm 23,5 x 23,5 x 14,8
kg 3,3

epal pallet cm 80 x 120

150 displays

**Classic
Maxi Bubbles**



AREA 1 AREA 2

113002010001

**Color
Maxi Bubbles**



AREA 1 AREA 2

113002010002

**Animal
Maxi Bubbles**



AREA 1 AREA 2

113002010005

**Unicorn
Maxi Bubbles**



AREA 1 AREA 2

113002010004

**Stitch
Maxi Bubbles**



AREA 1 AREA 2

113002010043

Mickey
Maxi Bubbles

PRODUCT



8 007315 420105

DISPLAY



8 007315 042017



AREA 1 AREA 2

113002010010

Minnie
Maxi Bubbles

PRODUCT



8 007315 584005

DISPLAY



8 007315 058407



AREA 1 AREA 2

113002010011

Princess
Maxi Bubbles

PRODUCT



8 007315 480109

DISPLAY



8 007315 048019



AREA 1 AREA 2

113002010012

Frozen
Maxi Bubbles

PRODUCT



8 007315 824507

DISPLAY



8 007315 082457



AREA 1 AREA 2

113002010013

Cars
Maxi Bubbles

PRODUCT



8 007315 491006

DISPLAY



8 007315 049108



AREA 1 AREA 2

113002010014

Disney Multi P. Maxi Bubbles



AREA 1 AREA 2

113002010018

Spider-Man Maxi Bubbles



AREA 1 AREA 2

113002010009

Hot Wheels / Barbie Maxi Bubbles



AREA 1 AREA 2

113002010038

Peppa Pig Maxi Bubbles



AREA 1 AREA 2

113002010023

PJ Masks Maxi Bubbles



AREA 1 AREA 2

113002010027

Bing Maxi Bubbles

PRODUCT



DISPLAY



AREA 1 AREA 2

113002010031

Gabby's Dollhouse Maxi Bubbles

PRODUCT



DISPLAY



AREA 1 AREA 2

113002010045

PAW Patrol Maxi Bubbles

PRODUCT



DISPLAY



AREA 1 AREA 2

113002010025

Bolle di sapone Soap bubbles



GLASS - display
300 ml - 10,5 fl oz UK

Safety commitment



Gluten Free.
Hypoallergenic.
Paraben Free.

Lotto di produzione
impresso sulla flacone.

*Batch of production
printed on the bottle.*

Liquido 100%
microbiologicamente
testato.

*100% microbiologically
tested solution.*

BOLLE DI SAPONE



Environmental commitment



Riempibile e
riutilizzabile.

*Refillable and
reusable.*



Componenti prodotto
interamente riciclabili.

*Product components
fully recyclable.*

Playability commitment

Soffiatore inserito
nel tappo.

Built-in wand.

Gioco sul tappo.

Game on the top.

Testato per resistere alle
diverse condizioni
climatiche.

*Tested to withstand
different climatic conditions.*

Pallina di plastica
(non si ossida).

*Plastic ball
(does not oxidize).*



DAT TECNICI - TECHNICAL DATA

display

12 pz / pcs
cm 20 x 26,5 x 17
kg 4,3

epal pallet cm 80 x 120

112 displays

Classic
Glass Bubbles

PRODUCT



DISPLAY



AREA 1

AREA 2

113003010001

Color
Glass Bubbles

PRODUCT



DISPLAY



AREA 1

AREA 2

113003010002

Animal
Glass Bubbles

PRODUCT



DISPLAY



AREA 1

AREA 2

113003010005

Unicorn
Glass Bubbles

PRODUCT



DISPLAY



AREA 1

AREA 2

113003010004

NEW!

Stitch
Glass Bubbles

PRODUCT



DISPLAY



AREA 1

AREA 2

113003010043

Mickey
Glass Bubbles



AREA 1 AREA 2

113003010010

Minnie
Glass Bubbles



AREA 1 AREA 2

113003010011

Princess
Glass Bubbles



AREA 1 AREA 2

113003010012

Frozen
Glass Bubbles



AREA 1 AREA 2

113003010013

Cars
Glass Bubbles



AREA 1 AREA 2

113003010014

Disney Multi P.
Glass Bubbles

PRODUCT
8 007315 838009

DISPLAY
8 007315 083805



AREA 1 AREA 2

113003010018

Avengers
Glass Bubbles

PRODUCT
8 007315 566001

DISPLAY
8 007315 056601



AREA 1 AREA 2

113003010017

Spider-Man
Glass Bubbles

PRODUCT
8 007315 516006

DISPLAY
8 007315 151603



AREA 1 AREA 2

113003010009

Barbie
Glass Bubbles

PRODUCT
8 007315 552004

DISPLAY
8 007315 155205



AREA 1 AREA 2

113003010021

Peppa Pig
Glass Bubbles

PRODUCT
8 007315 607001

DISPLAY
8 007315 060707



AREA 1 AREA 2

113003010023

NEW!

Bluey
Glass Bubbles

PRODUCT



DISPLAY



AREA 1

AREA 2

113003010036

Gabby's Dollhouse
Glass Bubbles

PRODUCT



DISPLAY



AREA 1

AREA 2

113003010045

Minions
Glass Bubbles

PRODUCT



DISPLAY



AREA 1

AREA 2

113003010028

PAW Patrol
Glass Bubbles

PRODUCT



DISPLAY



AREA 1

AREA 2

113003010025



x3

Gioco sul tappo visibile dall'esterno.
Game on the top visible from the outside.

Grafiche assortite dei flaconi.
Assorted bottle graphics.



Environmental
commitment



DAT TECNICI - TECHNICAL DATA	cartone / carton
	24 3-packs
	cm 24,5 x 32 x 24,5
	kg 6
	epal pallet cm 80 x 120
	77 ct / cts

SOAP BUBBLES

Disney Multi P.
Bubbles 3-pack



AREA 1 AREA 2

103010010018

Frozen
Bubbles 3-pack



AREA 1 AREA 2

103010010013

PAW Patrol
Bubbles 3-pack



AREA 1 AREA 2

103010010025

DISPONIBILE SU RICHIESTA (QUANTITÀ MINIMA NECESSARIA)
AVAILABLE UPON REQUEST (MINIMUM ORDER QUANTITY REQUIRED)

BOLLE DI SAPONE

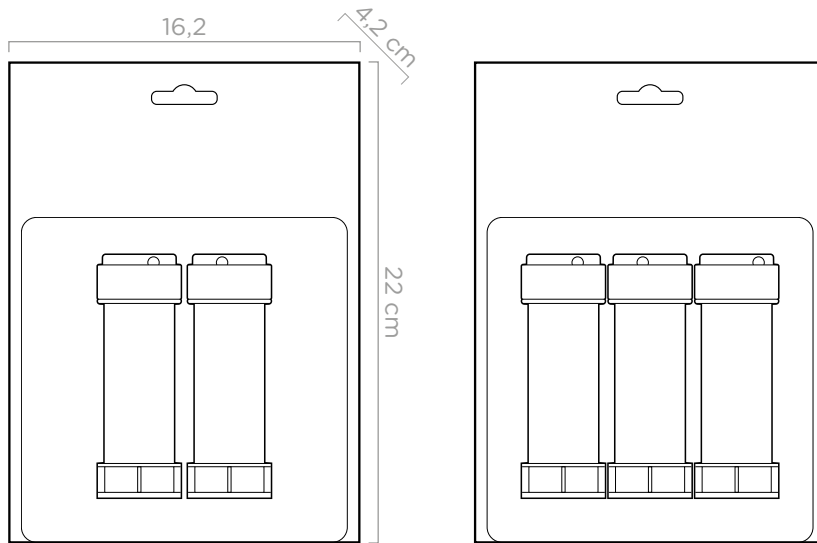

Per particolari campagne promozionali, attività speciali in-store o online.
DISPONIBILE SU RICHIESTA (QUANTITÀ MINIMA NECESSARIA)

*For particular promotional campaigns, special in-store activities or online shops.
AVAILABLE UPON REQUEST (MINIMUM ORDER QUANTITY REQUIRED)*



3-pack (32 pcs. per carton)



4-pack (24 pcs. per carton)



5-pack (20 pcs. per carton)



6-pack (16 pcs. per carton)



9-pack (8 pcs. per carton)



12-pack (8 pcs. per carton)



24-pack (4 pcs. per carton)

TECHNICAL DATA

Carton
cm 24,5 x 32 x 24,5 - kg 6,0

Pallet (high cm 187)
77 cartons

GLI EVENTI - CASE HISTORY

SOTTO LE STELLE DEL CINEMA



credits: Cineteca di Bologna

BOLLE DI SAPONE

BOLOGNA PORTICI FESTIVAL 2024



credits: Comune di Bologna, Giorgio Bianchi

BOLOGNA PORTICI FESTIVAL 2025



credits: Comune di Bologna

GIFFONI FILM FESTIVAL



PARMA CALCIO



TOUR DE FRANCE



Bolle di sapone per promuovere e comunicare il proprio brand.
Flaconi personalizzabili per eventi, sponsorship, giveaway o sviluppo di una propria linea di prodotto. Minimi d'ordini flessibili.

*Soap bubbles to promote and communicate your brand.
Customizable bottles for events, sponsorships, giveaways or development of your own product line. Flexible minimum order quantity.*

DIVERSI FORMATI DISPONIBILI
DIFFERENT SIZES AVAILABLE



YOUR
LOGO
HERE

- EVENTI / EVENTS
- SPONSORSHIP
- GIVEAWAY
- PUBBLICITÀ / ADS
- FESTIVITÀ / HOLIDAYS
- SOUVENIR

FESTIVITÀ
HOLIDAYS



EVENTI E
CELEBRAZIONI
EVENTS AND
CELEBRATIONS



SOUVENIR



CONTINUA / CONTINUE →



@BubbleWorldToys



by



Macchine Bolle *Bubble Machines*



Macchina Bolle Bubble Machine



USB BUBBLE MACHINE



Cavetto USB incluso.
USB cable included.

Serbatoio contenente 175ml
(6,15 fl.oz. UK) di liquido per bolle di sapone*.
175ml (6,15 fl.oz. UK) bubble* tank capacity.

*Liquido per bolle di sapone non incluso.
*Soap bubble solution not included.



Necessita 4 batterie AA.
4 AA Batteries needed.

Portatile.
Portable.

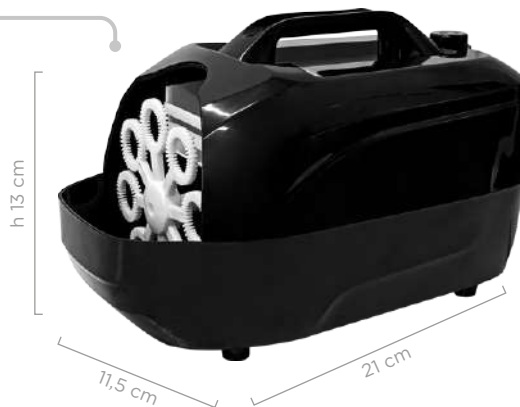

DAT TECNICI - TECHNICAL DATA

scatola / box
cm 23 x 12,5 x 14
kg 0,45

cartone / carton
12 boxes
cm 51 x 25 x 43
kg 8

epal pallet cm 80 x 120
24 ct / cts

NEW!

USB Bubble Machine



AREA 1 AREA 2

500042010000

BUBBLE MACHINES

Macchina Bolle Bubble Machine



BUBBLE MACHINE



Alimentatore di rete incluso.
Power supply included.

Serbatoio contenente 300ml
(10,55 fl.oz. UK) di liquido per bolle di sapone*.
300ml (10,55 fl.oz. UK) bubble* tank capacity.

*Liquido per bolle di sapone non incluso.
*Soap bubble solution not included.



Necessita 2 batterie C.
2 C Batteries needed.

Portatile.
Portable.

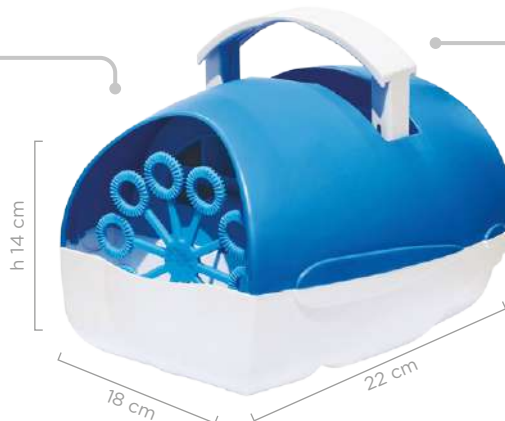

Manico retrattile.
Retractable handle.

DAT TECNICI - TECHNICAL DATA

scatola / box
cm 19,5 x 28 x 17
Kg 0,8

epal pallet cm 80 x 120
96 ct / cts

Bubble Machine

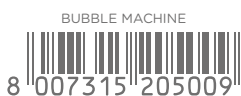

AREA 1 AREA 2

500034010000

Ricarica bolle

Bubble refill



BUBBLE REFILL

**Safety
commitment**



Gluten Free.
Hypoallergenic.
Paraben Free.

Lotto di produzione
impresso sul flacone.
*Batch of production
printed on the bottle.*

Liquido 100%
microbiologicamente
testato.
*100% microbiologically
tested solution.*

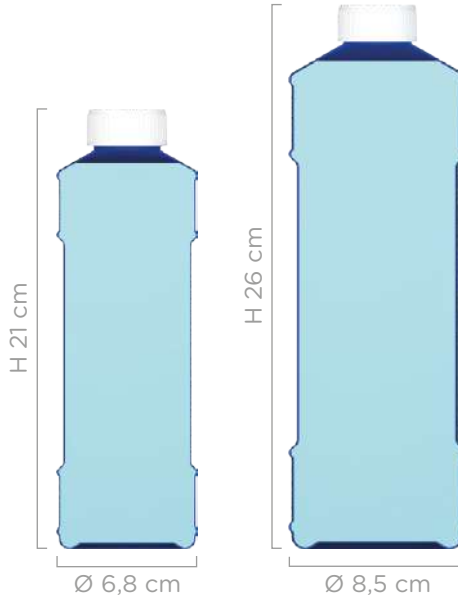

**Environmental
commitment**

Flacone e tappo in
mono materiale.
*Mono-material bottle
and cap.*

Componenti prodotto
interamente riciclabili.
*Product components
fully recyclable.*

REFILL 0.5

flacone / bottle
0,5 L - 17,5 fl oz UK
cartone / carton
25 pz/pcs
cm 35,3 x 35,3 x 23,2
kg 14
epal pallet cm 80 x 120
42 ct / cts

DAT TECNICI - TECHNICAL DATA

Playability commitment

Testato per resistere alle diverse condizioni climatiche.
Tested to withstand different climatic conditions.

Pronto all'uso.
Ready to use.

**LIQUIDO MULTIUSO PER BOLLE E GIOCABOLLE.
MULTIPURPOSE SOLUTION FOR BUBBLES AND BUBBLE TOYS.**

REFILL 1.0

flacone / bottle
1 L - 35,1 fl oz UK
cartone / carton
12 pz/pcs
cm 26 x 34,5 x 28
kg 13,1
epal pallet cm 80 x 120
45 ct / cts

DAT TECNICI - TECHNICAL DATA

RICARICA BOLLE

**Bubble
Refill 0.5**



AREA 1 **AREA 2**

103004010000

**Bubble
Refill 1.0**



AREA 1 **AREA 2**

103005010000

**Safety
commitment**



Gluten Free.
Hypoallergenic.
Paraben Free.

Lotto di produzione
impresso sul flacone.
*Batch of production
printed on the bottle.*

Liquido 100%
microbiologicamente
testato.
*100% microbiologically
tested solution.*

**Environmental
commitment**

Flacone e tappo in
mono materiale.
*Mono-material bottle
and cap.*

Componenti prodotto
interamente riciclabili.
*Product components
fully recyclable.*



REFILL 3.0

flacone / bottle
3 L - 0,66 gal UK
cartone / carton
4 pz/pcs
cm 40 x 30 x 19
kg 13,3
epal pallet cm 80 x 120
40 ct / cts

DAT TECNICI - TECHNICAL DATA

Playability commitment

Testato per resistere alle diverse condizioni climatiche.
Tested to withstand different climatic conditions.

Pronto all'uso.
Ready to use.

**LIQUIDO MULTIUSO PER BOLLE E GIOCABOLLE.
MULTIPURPOSE SOLUTION FOR BUBBLES AND BUBBLE TOYS.**

REFILL 5.0

flacone / bottle
5 L - 1,09 gal UK
kg 5,40
epal pallet cm 80 x 120
90 pz / pcs

DAT TECNICI - TECHNICAL DATA

**Bubble
Refill 3.0**



AREA 1 **AREA 2**

103006010000

**Bubble
Refill 5.0**



AREA 1 **AREA 2**

123007010000

BUBBLE REFILL



@BubbleWorldToys



by



Giocabolle™ *Bubble Toys*



BUBBLE TOYS

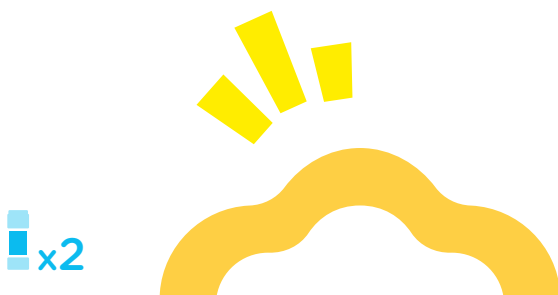

DAT TECNICI - TECHNICAL DATA	box
	cm 17 x 19 x 14,3
	cartone / carton
	12 pz / pcs cm 45 x 36 x 40
	epal pallet cm 80 x 120
	16 ct / cts

GIOCABOLLE

NEW!

Cactus
Bubble Machine



AREA 1

AREA 2

500040010001

Keep the
Crazy
Crab
bubblin'!



Tre modalità di gioco:
Three game modes:

modalità 1: corre, si illumina
e fa musica
mode 1: runs, make lights
and play music



modalità 2: fa bolle, si illumina
e fa musica
mode 2: blows bubbles, make lights
and play music



modalità 3: corre, fa bolle,
si illumina e fa musica
mode 3: runs, blows bubbles,
make lights and play music



 Necessita 4
batterie AAA.
4 AAA Batteries
needed.

 x2



DAT TECNICI - TECHNICAL DATA	box
	cm 19 x 13,5 x 15
	cartone / carton
	12 pz / pcs cm 43 x 42 x 33
	epal pallet cm 80 x 120
	20 ct / cts

BUBBLE TOYS

NEW!

**Crazy Crab
Bubble Machine**



AREA 1 **AREA 2**

500039010001

Due modalità di gioco:
Two game modes:

modalità 1 per
luci e bolle
mode 1 for lights
and bubbles



modalità 2 per bolle,
luci e rotazione della testa
mode 2 for bubbles,
lights and spinning head



Necessita 4 batterie AA.
4 AA Batteries needed.

x2



DAT TECNICI - TECHNICAL DATA	box
	cm 16,8 x 16,8 x 16,8
	cartone / carton
	12 pz / pcs cm 46 x 42 x 34
	epal pallet cm 80 x 120
	10 ct / cts

NEW!

**Octopus
Bubble Machine**



AREA 1 AREA 2

500037010001



Necessita 3 batterie AA.
3 AA Batteries needed.

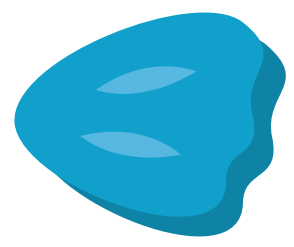

x2



DAT TECNICI - TECHNICAL DATA	box
	cm 26,6 x 18,1 x 9,7
	cartone / carton
	12 pz / pcs cm 61 x 29 x 38
epal pallet	cm 80 x 120
	20 ct / cts

BUBBLE TOYS

NEW!

**Seahorse
Bubble Blaster**

BOX
8 007315 009973



AREA 1 **AREA 2**

500038010001

Safety commitment



Gluten Free.
Hypoallergenic.
Paraben Free.

Lotto di produzione
impresso sulla spada.

*Batch of production
printed on the wand.*

Liquido 100%
microbiologicamente
testato.

*100% microbiologically
tested solution.*

Playability commitment

Soffiatore inserito nel
manico per fare bolle maxi.

*Built-in wand to make
maxi bubbles.*

Foro grande adatto ai
ganci espositori.

*Large hollow for easy
hanging in universal
blister hooks.*

Testato per resistere alle
diverse condizioni
climatiche.

*Tested to withstand
different climatic conditions.*



Environmental commitment



Riempibile e
riutilizzabile.
*Refillable and
reusable.*



Componenti prodotto
interamente riciclabili.
*Product components
fully recyclable.*

DAT TECNICI - TECHNICAL DATA

spada / wand

120 ml - 4,2 fl oz UK

display

24 pz / pcs
cm 16 x 23 x 39
kg 4,1

epal pallet cm 80 x 120

125 ct / cts

GIOCABOLLE

Classic
Bubble Wand 120ml



AREA 1

AREA 2

500025010001

Animal
Bubble Wand 120ml



AREA 1

AREA 2

500025010005

Unicorn
Bubble Wand 120ml



AREA 1 AREA 2

500025010004

Stitch
Bubble Wand 120ml



AREA 1 AREA 2

500025010043

Mickey
Bubble Wand 120ml



AREA 1 AREA 2

500025010010

Minnie
Bubble Wand 120ml



AREA 1 AREA 2

500025010011

Princess
Bubble Wand 120ml



AREA 1 AREA 2

500025010012

Frozen
Bubble Wand 120ml



AREA 1 AREA 2

500025010013

Disney Multi P.
Bubble Wand 120ml



AREA 1 AREA 2

500025010018

Avengers
Bubble Wand 120ml



AREA 1 AREA 2

500025010017

Spider-Man
Bubble Wand 120ml



AREA 1 AREA 2

500025010009

NEW!

Hello Kitty & Friends
Bubble Wand 120ml



AREA 1 AREA 2

500025010052

NEW!

Modern Sonic
Bubble Wand 120ml

PRODUCT



8 007315 010429

DISPLAY



8 007315 010405



AREA 1

AREA 2

500025010056

Peppa Pig
Bubble Wand 120ml

PRODUCT



8 007315 199506

DISPLAY



8 007315 019958



AREA 1

AREA 2

500025010023

Bing
Bubble Wand 120ml

PRODUCT



8 007315 198004

DISPLAY



8 007315 019804



AREA 1

AREA 2

500025010031

Gabby's Dollhouse
Bubble Wand 120ml

PRODUCT



8 007315 008075

DISPLAY



8 007315 008082



AREA 1

AREA 2

500025010045

Minions
Bubble Wand 120ml

PRODUCT



8 007315 194006

DISPLAY



8 007315 019408



AREA 1

AREA 2

500025010028

BUBBLE TOYS

PAW Patrol
Bubble Wand 120ml



AREA 1

AREA 2

500025010025



x1



Environmental commitment

MADE WITH RECYCLED PLASTIC
30%

FUNZIONA SENZA BATTERIE
NO BATTERIES NEEDED

Premere:

- a) continuamente per una lunga fila di bolle
- b) ad intervalli per bolle grandi.

Pull the trigger:

- a) continuously to get a lot of bubbles
- b) intermittently to get big bubbles.

Pistola Meccanica
Mechanical Gun

blistercard
cm 16 x 22

cartone / carton
27 blistercards
cm 20,5 x 80,5 x 28,5
kg 4,4

epal pallet cm 80 x 120
42 ct / cts

DAT TECNICI - TECHNICAL DATA

Classic
Bubble Gun - Small

GUN SMALL

8 007315 960007

AREA 1 AREA 2

500026010001

Animal
Bubble Gun - Small

GUN SMALL

8 007315 176019

AREA 1 AREA 2

500026010005

Unicorn
Bubble Gun - Small

GUN SMALL

8 007315 175012

AREA 1 AREA 2

500026010004

BUBBLE TOYS

NEW!

Stitch
Bubble Gun - Small



AREA 1 **AREA 2**

500026010043

Mickey
Bubble Gun - Small



AREA 1 **AREA 2**

500026010010

Minnie
Bubble Gun - Small



AREA 1 **AREA 2**

500026010011

Frozen
Bubble Gun - Small



AREA 1 **AREA 2**

500026010013

Cars
Bubble Gun - Small



AREA 1 **AREA 2**

500026010014

GIOCABOLLE



Spider-Man
Bubble Gun - Small



AREA 1 AREA 2

500026010009

Peppa Pig
Bubble Gun - Small



AREA 1 AREA 2

500026010023

Bing
Bubble Gun - Small



AREA 1 AREA 2

500026010031

Gabby's Dollhouse
Bubble Gun - Small



AREA 1 AREA 2

500026010045

PAW Patrol
Bubble Gun - Small



AREA 1 AREA 2

500026010025

BUBBLE TOYS



x1



Environmental
commitment



FUNZIONA SENZA BATTERIE
NO BATTERIES NEEDED

DAT TECNICI - TECHNICAL DATA

cartone / carton
48 guns
cm 20,5 x 80,5 x 28,5
kg 6,4

epal pallet cm 80 x 120

42 ct / cts

Premere:

- a) continuamente per una lunga fila di bolle
- b) ad intervalli per bolle grandi.

Pull the trigger:

- a) continuously to get a lot of bubbles
- b) intermittently to get big bubbles.



Pistola Meccanica
Mechanical Gun

Classic
Bubble Gun - Small
(shrink-film)

GUN SMALL (SHRINK-FILM)



8 007315 280006



AREA 1

AREA 2

500027010001

Mickey
Bubble Gun - Small
(shrink-film)

GUN SMALL (SHRINK-FILM)



8 007315 080507



AREA 1

AREA 2

500027010010

Minnie
Bubble Gun - Small
(shrink-film)

GUN SMALL (SHRINK-FILM)



8 007315 084505



AREA 1

AREA 2

500027010011

Frozen
Bubble Gun - Small
(shrink-film)

GUN SMALL (SHRINK-FILM)



AREA 1 AREA 2

500027010013

Spider-Man
Bubble Gun - Small
(shrink-film)

GUN SMALL (SHRINK-FILM)



AREA 1 AREA 2

500027010009

PAW Patrol
Bubble Gun - Small
(shrink-film)

GUN SMALL (SHRINK-FILM)



AREA 1 AREA 2

500027010025





Con luce (batterie incorporate).
With light (built-in batteries).

x1

Premere:

- a) continuamente per una lunga fila di bolle
- b) ad intervalli per bolle grandi.

Pull the trigger:

- a) continuously to get a lot of bubbles
- b) intermittently to get big bubbles.



Pistola Meccanica
Mechanical Gun

Environmental commitment



NESSUNA BATTERIA DA AGGIUNGERE
NO BATTERIES TO ADD

DATI TECNICI - TECHNICAL DATA

blistercard

cm 18,5 x 24

cartone / carton

20 blistercards
cm 20,5 x 80,5 x 28,5
kg 3,9

epal pallet cm 80 x 120

42 ct / cts

Classic

Bubble Gun - Medium

GUN MEDIUM



8 007315 085007



AREA 1

AREA 2

500028010001

Unicorn

Bubble Gun - Medium

GUN MEDIUM



8 007315 210515



AREA 1

AREA 2

500028010004

Stitch

Bubble Gun - Medium

GUN MEDIUM



8 007315 008518



AREA 1

AREA 2

500028010043

Mickey
Bubble Gun - Medium



AREA 1 AREA 2

500028010010

Frozen
Bubble Gun - Medium



AREA 1 AREA 2

500028010013

Spider-Man
Bubble Gun - Medium



AREA 1 AREA 2

500028010009

Gabby's Dollhouse
Bubble Gun - Medium



AREA 1 AREA 2

500028010045

PAW Patrol
Bubble Gun - Medium



AREA 1 AREA 2

500028010025

BUBBLE TOYS



Environmental
commitment



FUNZIONA SENZA BATTERIE
NO BATTERIES NEEDED

Bolle senza fine: le bolle escono senza sosta fino a che si preme ripetutamente il grilletto.
Endless bubbles: pull the trigger repeatedly for a continuous flow of bubbles.

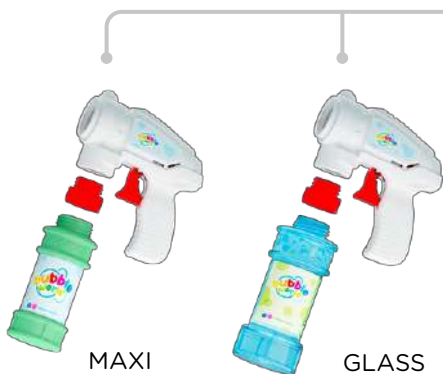

MAXI

GLASS

x1

Connettore universale per tutti i flaconi BUBBLE WORLD™ (Standard, Maxi, Glass, ecc.)
Universal connector for all our BUBBLE WORLD™ bottles (Standard, Maxi, Glass, etc.)



Pistola Meccanica
Mechanical Gun

DAT TECNICI - TECHNICAL DATA

blistercard
cm 21 x 26

cartone / carton
12 blistercards
cm 20,5 x 80,5 x 28,5
kg 3,32

epal pallet cm 80 x 120
42 ct / cts

GIOCABOLLE

Classic
Bubble Gun Plus



AREA 1

AREA 2

500029010001

Environmental
commitment



Bacchette modulari
per bolle giganti
*Modular sticks
for giant bubbles*

Vaschetta
contenitore
Bowl

2x175= 350 ml
di liquido bolle
*2x175= 350 ml
of bubble solution*

DATI TECNICI - TECHNICAL DATA

box	cm 6,5 x 15 x 27
cartone / carton	12 box
	cm 20,5 x 80,5 x 28,5
	kg 7,2
epal pallet	cm 80 x 120
	42 ct / cts



Classic
Giant Bubble Kit

GIANT BUBBLE KIT



AREA 1 AREA 2

500032010001

BUBBLE TOYS

Environmental
commitment

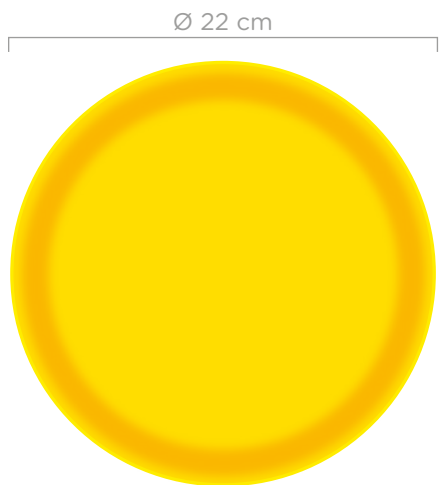

Ø 22 cm

Soffiatore multiplo per fare bolle giganti e piccole.
Multiple bubble blower to make giant and small bubbles.

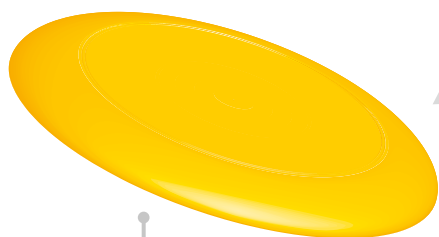
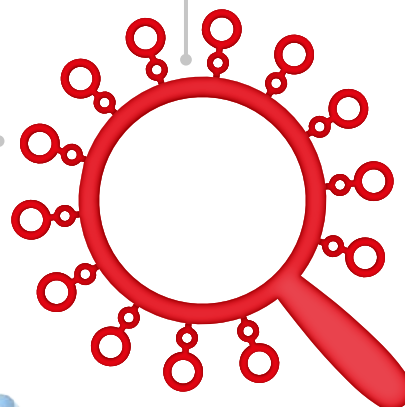

Attacca l'adesivo in dotazione sopra il flying Disc.
Attach the supplied sticker on the flying disc.

Capovolgi il piatto e gioca col flying disc.
Flip the plate and play with the flying disc.

DAT TECNICI - TECHNICAL DATA	blistercard
	cm 24,5 x 34,5
	cartone / carton
	12 blistercards cm 20,5 x 80,5 x 28,5 kg 5,1
	epal pallet cm 80 x 120
	42 ct / cts

x3

GIOCABOLLE

Classic
Flying Disc &
Giant Bubbles

FLYING DISC & GIANT BUBBLES



8 007315 500111



AREA 1 AREA 2

500030010001

Mickey
Flying Disc &
Giant Bubbles

FLYING DISC & GIANT BUBBLES



8 007315 110501



AREA 1 AREA 2

500030010010

Minnie
Flying Disc &
Giant Bubbles

FLYING DISC & GIANT BUBBLES



8 007315 111003



AREA 1 AREA 2

500030010011

Frozen
Flying Disc &
Giant Bubbles

FLYING DISC & GIANT BUBBLES



8 007315 115506



AREA 1 AREA 2

500030010013

Cars
Flying Disc &
Giant Bubbles

FLYING DISC & GIANT BUBBLES



8 007315 111508



AREA 1 AREA 2

500030010014

Spider-Man
Flying Disc &
Giant Bubbles

FLYING DISC & GIANT BUBBLES



8 007315 112000



AREA 1 AREA 2

500030010009

PJ Masks
Flying Disc &
Giant Bubbles

FLYING DISC & GIANT BUBBLES



8 007315 117005



AREA 1 AREA 2

500030010027

BUBBLE TOYS

Minions Flying Disc & Giant Bubbles

FLYING DISC & GIANT BUBBLES



8 007315 114509



AREA 1

AREA 2

500030010028

PAW Patrol Flying Disc & Giant Bubbles

FLYING DISC & GIANT BUBBLES



8 007315 117500



AREA 1

AREA 2

500030010025

GIOCABOLLE



Bolle di plastica e palline

Plastic Bubbles & Marbles





Contenuto: 30gr.
Content: 30gr.

Pasta gradevole all'olfatto.
Pleasant olfactive smell paste.

Ideali 365 giorni all'anno e
per luoghi al chiuso.
Ideal all year around
and for indoor.

H 10,5 cm



Ø 2,8 cm

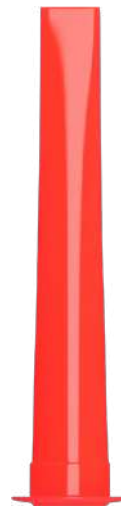

Cannuccia con valvola di
sicurezza che impedisce
l'inspirazione.
Straw with safety
valve that prevents the
inhalation.



DAT TECNICI - TECHNICAL DATA	display
	24 pz / pcs cm 17 x 25,2 x 11
	cartone / carton
	12 displays 288 pz/pcs cm 27,5 x 52 x 48 kg 17,4
	epal pallet cm 80 x 120 18 ct / cts

DAT TECNICI - TECHNICAL DATA	blistercard
	cm 16,2 x 22
	cartone / carton
	24 blistercards cm 25 x 32 x 25 kg 1,7
	epal pallet cm 80 x 120 77 ct / cts

Balloo Ball



AREA 1 AREA 2

103023010000

Balloo Ball Blister



AREA 1 AREA 2

103024010000

Espositore pall-box Balloo Ball
Balloo Ball floor display



DAT TECNICI - TECHNICAL DATA	pall box
	1 pall-box cm 40 x 60 x 87 kg 8,78
	epal pallet cm 80 x 120
	8 ct / cts

133023110001
Pall box Balloo Ball 96 pcs.

DAT TECNICI - TECHNICAL DATA	pall box
	1 pall-box cm 40 x 60 x 87 kg 11,28
	epal pallet cm 80 x 120
	8 ct / cts

133023010000
Pall box Balloo Ball 144 pcs.



Ø 3,7 cm

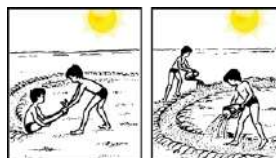

DRAW

WET



PLAY

DAT TECNICI - TECHNICAL DATA

retina / net
9 pz / pcs

interno / inner
24 retine / nets

cartone / carton
216 retine / nets
cm 42 x 59 x 53
kg 15

epal pallet cm 80 x 120
12 ct / cts

Ciclisti

Palline di plastica

PRODUCT



AREA 1 AREA 2

103033010039

Sport Car

Palline di plastica

PRODUCT



AREA 1 AREA 2

103033010040

Motor Bike

Palline di plastica

PRODUCT



AREA 1 AREA 2

103033010041

Disney Multi P.

Palline di plastica

PRODUCT



AREA 1 AREA 2

103033010018



Ø 25 mm

1

+



Ø 16 mm

20

Dimensioni 1:1
1:1: Dimensions



DAT TECNICI - TECHNICAL DATA

retina / net	21 pz / pcs
cartone / carton	20 retine / nets
	cm 26,5 x 17,8 x 9,8
	kg 3
epal pallet cm 80 x 120	288 ct / cts

Princess
Glass Marbles
Assorted

PRODUCT



AREA 1 AREA 2

500420000



Cars
Glass Marbles
Assorted

PRODUCT



AREA 1 AREA 2

500410000



Trolls
Glass Marbles
Assorted

PRODUCT



AREA 1 AREA 2

500450000





@BubbleWorldToys



by



Pall-box *Floor Display*



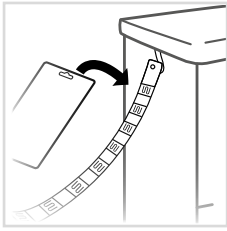

Clip strip laterali complete di ganci per una maggiore superficie espositiva.
Side clip strips and hooks for a larger display area.



Retro pall-box decorato: può essere collocato in posizioni espositive centrali del punto vendita.

Backside decorated pall-box: it can be exhibited in a central position of the shop.



DAT TECNICI - TECHNICAL DATA	
cartone / carton	
1 pall-box	
cm 29 x 52,5 x 163	
kg 2	
epal pallet cm 80 x 120	
6 ct / cts	

Esempio multiprodotto con clip strip laterali.
Example multiproduct with side clip strips.



Esempio monoprodotto.
Example monoproduct.



Esempi di possibili assortimenti
Examples of potential assorted displays

Bubble World: una bolla, un sorriso

Bubble World: one bubble, one smile

Crediamo che una bolla di sapone sia uno strumento potente, in grado di regalare un sorriso a chi ne ha più bisogno. Una magia adatta a tutti e per tutte le età.

Ogni anno sosteniamo associazioni e scuole attraverso la donazione delle nostre bolle di sapone e collaboriamo con numerose realtà impegnate nel sociale e nel sostegno pediatrico attraverso attività e raccolte fondi finalizzate all'acquisto di materiali e attrezzature medico-scientifiche.

We believe that soap bubbles are powerful tools, capable of bringing a smile to those who need it the most. They are magic, suitable for everyone and for all ages. Every year, we support associations and schools through donations of our soap bubbles and we collaborate with numerous charities engaged in social and pediatric support aimed at purchasing materials and medical-scientific equipment.



INDOOR BUBBLES

PETS BUBBLES

BOLLE DI SAPONE

BUBBLE MACHINES

RICARICA BOLLE

GIOCABOLLE

BOLLE DI PLASTICA E PALLINE

PALL-BOX



HAPPINESS MADE IN ITALY



Dulcop International S.p.A.
via Lombardia 48, 40024 Castel San Pietro Terme (Bologna), Italy
tel: +39 051 625 0711 • corporate e-mail: info@dulcop.com